



Screw-Type Volumetric Flow Meter for Viscous Media



measuring
•
monitoring
•
analysing

OM...



Model: ADI-K...

- Measuring ranges:
0,1-10 ... 50-5000 L/min liquid
- Measuring accuracy: $\pm 0,3\%$ of reading
- p_{\max} : 420 bar; t_{\max} : 200 °C
- Viscosity range: 1-5000 mm²/s
- Connection: G 1/2 female ... G 6 female,
flange DN 15 ... DN 150
- Material: Cast iron, stainless steel
- Output: pulses
- Pulsation-free principle of measurement

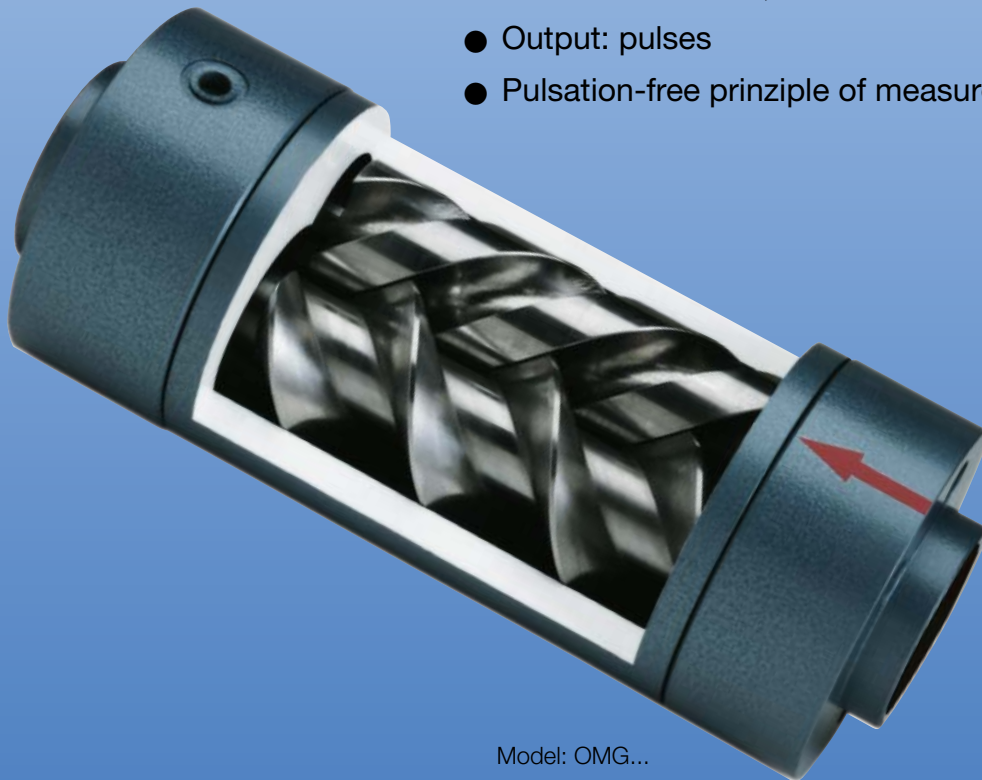

Model: OMG...



KOBOLD companies worldwide:

ARGENTINA, AUSTRIA, BELGIUM, BULGARIA, CANADA, CHILE, CHINA, COLUMBIA, CZECHIA, DOMINICAN REPUBLIC, EGYPT, FRANCE, GERMANY, GREAT BRITAIN, HUNGARY, INDIA, INDONESIA, ITALY, MALAYSIA, MEXICO, NETHERLANDS, PERU, POLAND, ROMANIA, SINGAPORE, SOUTH KOREA, SPAIN, SWITZERLAND, TAIWAN, THAILAND, TUNISIA, USA, VIETNAM

KOBOLD Messring GmbH
Nordring 22-24
D-65719 Hofheim/Ts.
Head Office:
+49(0)6192 299-0
+49(0)6192 23398
info.de@kobold.com
www.kobold.com

Description

The KOBOLD screw-type volumetric flow meter based on the principle of positive displacement was developed in response to the need to measure and control viscous media.

It was specially designed to measure viscous media with non-abrasive properties. Variations in viscosity in the range 1 to 5000 mm²/s have no effect on measurement results within the measuring accuracy.

The KOBOLD screw-type volumetric flow meter satisfies the stringent demands for greater accuracy, reliability and economic efficiency. Two spindles with cycloidal profiles form the basis of the screw-type volumetric flow meter.

Spindles manufactured with extreme precision are supported at each end with a ball bearing.

The axially forced measuring medium causes the spindles to rotate uniformly.

The rotary motion is picked off with inductive proximity switches and converted to a frequency signal. An exact measurement of the delivered flow volume is obtained with the volumetrically defined measuring chambers.

Combined with downstream evaluation electronics, the KOBOLD screw-type volumetric flow meter becomes a flexible measurement and control system for viscous media

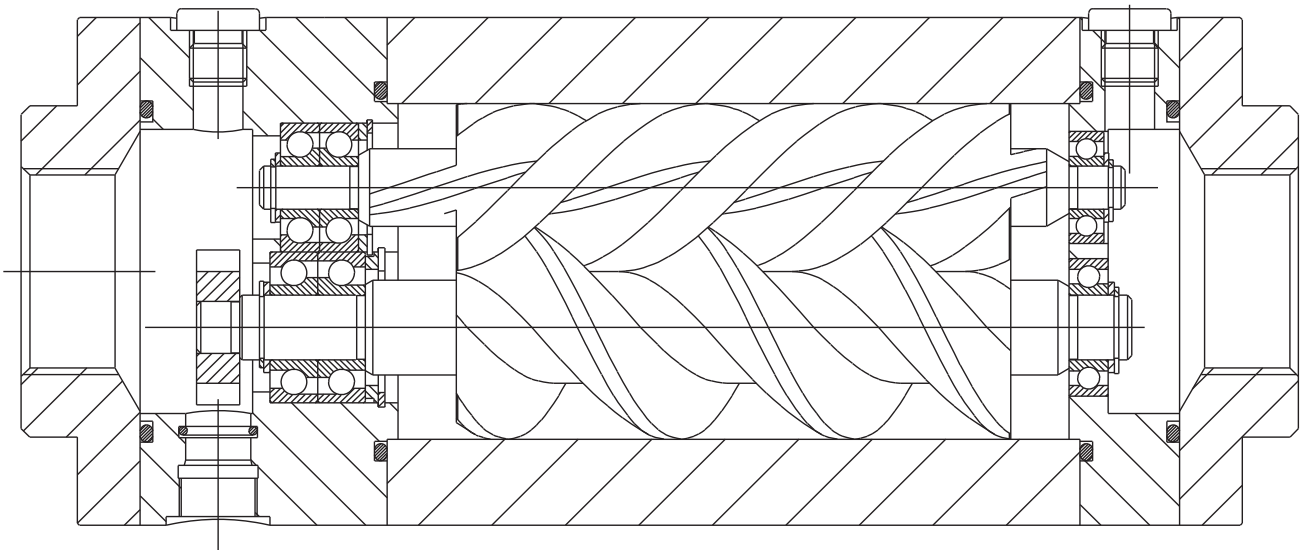

Benefits

- Greater viscosity range (1 bis 5000 mm²/s)
- Greater measuring accuracy (max. 0,3% of reading)
- Greater measuring range (1:70)
- Almost completely insensitive to viscosity
- Greater flow rate combined with minimum space requirements
- High degree of operational reliability and long service life
- Pulsation-free principle of measurement
- Self-cleaning measuring chambers
- Choice of installation position

Areas of Application

- **Furnaces**
EL heating oil, S heating oil, diesel oil
- **Hydraulics, test stands**
Hydraulic oil, lubricating oil, gear oil
- **Mixing and dosing systems**
Polyhydroxy alcohol, isocyanate
Additives for gasoline, cement...
- **Lacquers and fills, printing inks**
- **Chemical industry**
Acids and lyes, ethyl alcohol, freon
- **Food industry**
Margarine, fats, liqueur, oils

Standard version



Material

Housing: cast iron EN-GJS-400
 Spindles: Steel nitrated
 O-rings: FPM
 Bearings: Deep-grooved ball bearings with metal retainers
 Thread for sensors: M 18 x 1 with O-ring in the case
 Viscosity range: 1 - 5000 mm²/s
 Flange: Steel (material no. 1.7139)
 Rotor: Steel
 Operating temperature: -20 ... +200 °C (Please note limitation due to pulse generator.)

Order Details (Example: **OMG-15F15P16/xx**) xx = pulse generator see page 7

Flowrate [L/min]	p _{max} ¹ [bar]	Pulses/L ²	Frequency ² [Hz]	Threaded connection		Flange connection		
				Order No.	G	Order No.	DN	p _{max} ^{1/3} [bar]
0.1 - 10	250	1216	2.0 - 203	OMG-15R15	½	OMG-15F15	15	16/40/64/100/160/250
0.3 - 30	250	640	3.2 - 320	OMG-20R20	¾	OMG-20F15 OMG-20F20	15 20	64/100/160/250 16/40
1 - 100	250	234	3.9 - 390	OMG-25R25	1	OMG-25F25 OMG-25F32	25 32	64/100/160/250 16/40
3.5 - 350	160	71	4.1 - 414	OMG-40R40	1½	OMG-40F40	40	16/40/64/100/160
7 - 700	100	39,8	4.6 - 464	OMG-50R50	2	OMG-50F50	50	16/40/100
20 - 2000	40	16.8	4.6 - 560	OMG-1HR1F	4	OMG-1HF1F	100	16/40
50 - 5000	40	8.85	7.4 - 738	OMG-1FR1F	6	OMG-1FF1F	150	16/40

¹ Please note limitations due to pulse generator.

² Pulse generator 44 and 45 have higher Pulse/L and output frequency (for values see type plate and on request)

³ Please specify the desired nominal pressure when placing your order (e.g. F15/16 = flange DN 15 PN 16).

Accuracy Diagram

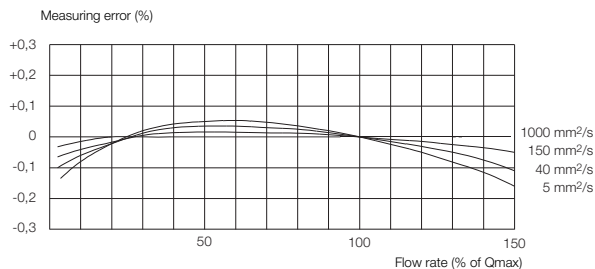

The measuring error refers to the actual flow rate. The diagram shows the characteristic for the OMG-... screw-type volumetric flowmeter. A test certificate is available because every device delivered is different.

Pressure Loss Diagram

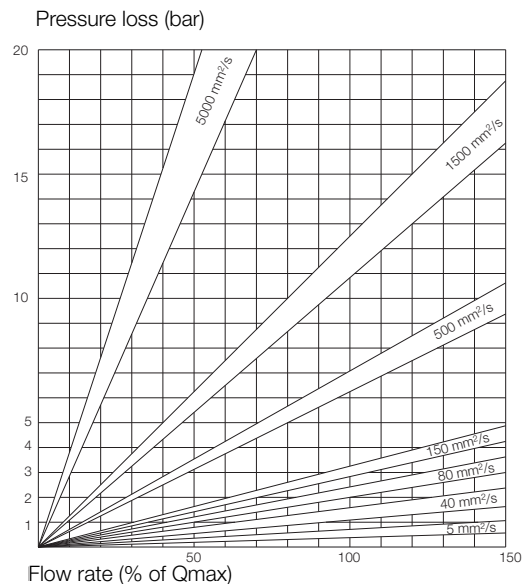



Material

- Housing: standard: st. steel (material no. 1.4301)
option: st. steel (material no. 1.4401)
- Spindles: PTFE + 15% graphite
- O-rings: FPM or silicone with FEP jacket
- Bearings: sliding-contact bearings between spindle and case
- Thread for sensors: M 18 x 1
with O-ring in the case
- Viscosity range: 1 - 5000 mm²/s
- Flange: st. steel (material no. 1.4301 or 1.4401)
- Rotor: steel, chemically nickel-plated,
option: st. steel 1.4401
- Operating temperature: -20... +40 °C or
(-20... +100 °C on request)
(Please note limitation due to pulse generator.)

Order Details (Example: OMK-15F15P16/xx) xx = pulse generator see page 7

Flow rate [L/min]	p _{max} [bar]	Pulses/L	Frequency [Hz]	Threaded connection		Flange connection ¹		
				Order no.	G	Order no.	DN	p _{max} [bar]
0.2 - 10	40	1200	4.0 - 200	OMK-15R15	1/2	OMK-50F50	15	16/40
0.6 - 30	40	640	6.4 - 320	OMK-20R20	3/4	OMK-20F20	20	16/40
2 - 100	40	230	7.7 - 383	OMK-25R25	1	OMK-25F25	25	16/40

¹ Please specify the desired nominal pressure when placing your order (e.g. F20/16 = flange DN 20 PN 16).

Accuracy Diagram

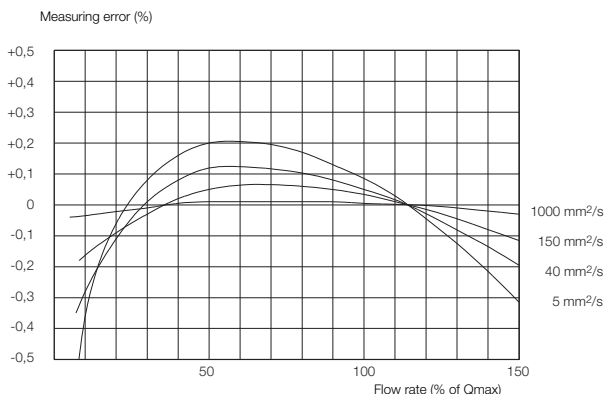

Pressure Loss Diagram

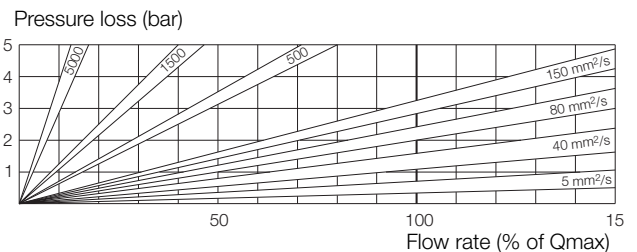

The measuring error refers to the actual flow rate. The diagram shows the characteristic for the OMK-... screw-type volumetric flowmeter. A test certificate is available because every device delivered is different.



Material

- Housing: standard: st. steel (material no. 1.4301)
option: st. steel (material no. 1.4401)
- Spindles: st. steel (material no. 1.4301), nitrated
or 1.4401, nitrated
- O-rings: FPM or silicone with FEP jacket
- Bearings: sliding-contact bearings;
special material
- Thread for sensors: M 18 x 1
with O-ring in the case
- Viscosity range: 1 - 5000 mm²/s
- Flange: st. steel (material no. 1.4301 or 1.4401)
- Rotor: steel, chemically nickel-plated,
option: st. steel 1.4401
- Operating temperature: -20... +100 °C (Please note limitation
due to pulse generator.)

Order Details (Example: **OMK-40F40P16/xx**) xx = pulse generator see page 7

Flow rate [L/min]	p _{max} [bar]	Pulses/L	Frequency [Hz]	Threaded connection		Flange connection ¹ Sealing face form C, according to DIN 2526		
				Order no.	G	Order no.	DN	p _{max} [bar]
3.5 - 350	40	71	4.1 - 414	OMK-40R40	1½	OMK-40F40	40	16/40
7 - 700	40	40	4.7 - 467	OMK-50R50	2	OMK-40F20	50	16/40

¹ Please specify the desired nominal pressure when placing your order (e.g. F40/16 = flange DN 40 PN 16).

Accuracy Diagram

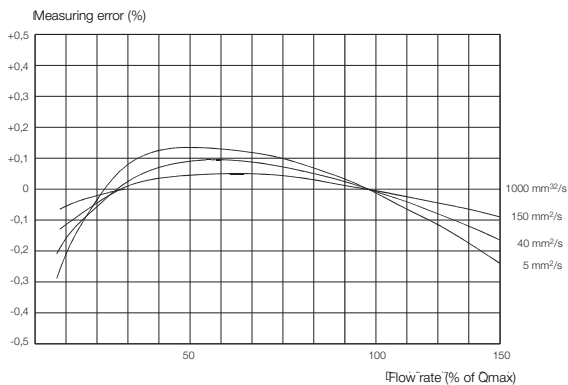

Pressure Loss Diagram

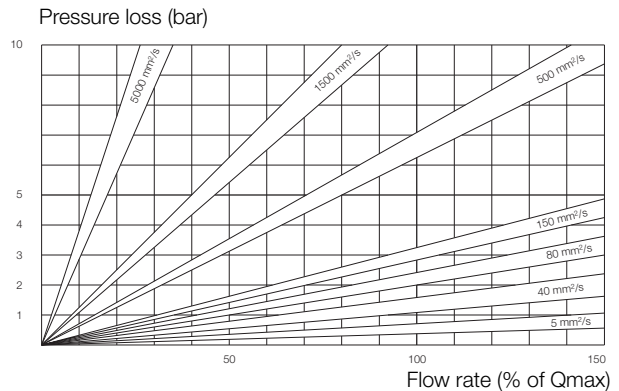

The measuring error refers to the actual flow rate. The diagram shows the characteristic for the OMK... screw-type volumetric flowmeter. A test certificate is available because every device delivered is different.



Material

Housing:	cast iron (GGGC-40)
Spindles:	st. steel (ma), nitrated
O-rings:	FPM
Bearings:	Deep-grooved ball bearings with metal retainers
Thread for sensors:	M 18 x 1 with O-ring in the case
Viscosity range:	1 - 5000 mm ² /s
Flange:	Steel (material no. 1.7139)
Operating temperature:	-20 ... +200 °C (Please note limitation due to pulse generator.)

Order Details (Example: **OMH-15F15P15/xx**) xx = pulse generator see page 7

Flow rate [L/min]	p _{max} ¹ [bar]	Pulses/L ²	Frequency ² [Hz]	Threaded connection		Flange connection ³ Sealing face form C, according to DIN 2526		
				Order no.	G	Order no.	DN	p _{max} ¹ [bar]
0.1 - 10	420	2432	4.1 - 405	OMH-15R15	½	OMH-15F15	15	400
0.3 - 30	420	1280	6.4 - 640	OMH-20R20	¾	OMH-20F15	15	400
1 - 100	420	468	7.4 - 780	OMH-25R25	1	OMH-25F25	25	400
3.5 - 350	420	142	8.3 - 828	OMH-40R40	1½	OMH-40F40	40	400
7 - 700	420	79,6	9.3 - 929	OMH-50R50	2	OMH-50F50	50	400
20 - 2000	250	33,6	11.2 - 1120	OMH-1HR1H	4	OMH-1HF1H	100	250

¹ Please note limitations due to pulse generator.

² Pulse generator 45 has higher Pulse/L and output frequency (for values see type plate and on request)

³ Please specify the desired nominal pressure when placing your order (e.g. F40/16 = flange DN 40 PN 16).

Accuracy Diagram

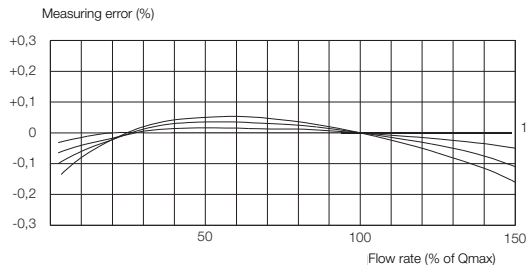

The measuring error refers to the actual flow rate. The diagram shows the characteristic for the OMH-... screw-type volumetric flowmeter. A test certificate is available because every device delivered is different.

Pressure Loss Diagram

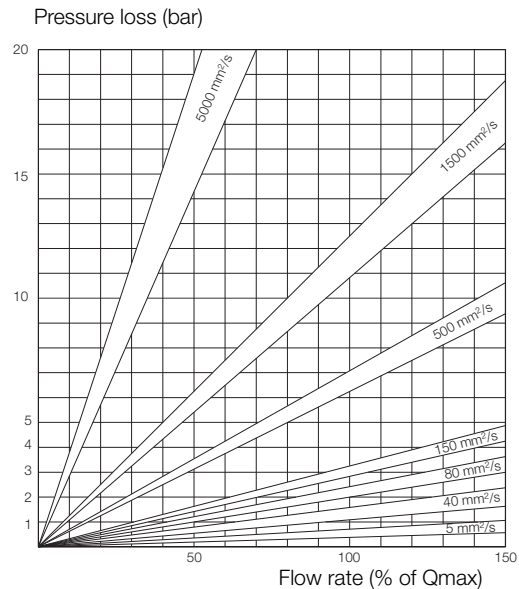

Method of Operation

The rotor of the screw-type volumetric flow meter rotates at a precisely defined distance in front of the pulse generator. The pulse generator generates a pulse for every pole that moves past it.

The screw-type volumetric flow meter is checked and delivered with a built-in dry sleeve. The transmitter insert for the pulse generator can be replaced online in a full line, without having to re-adjust the clearance to the rotor.

OM.../43 and OM.../46

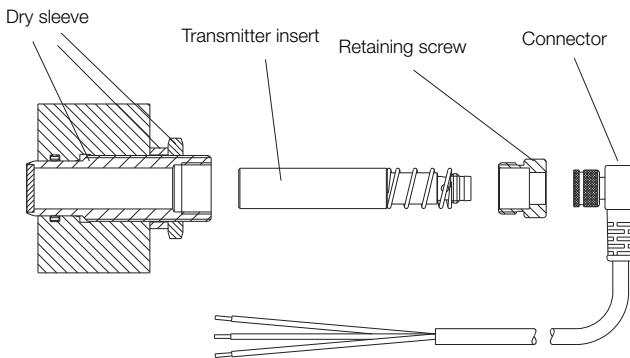

OM.../44 and OM.../47

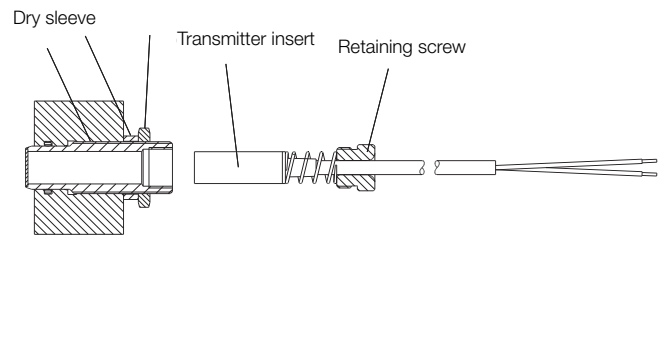

OM.../45

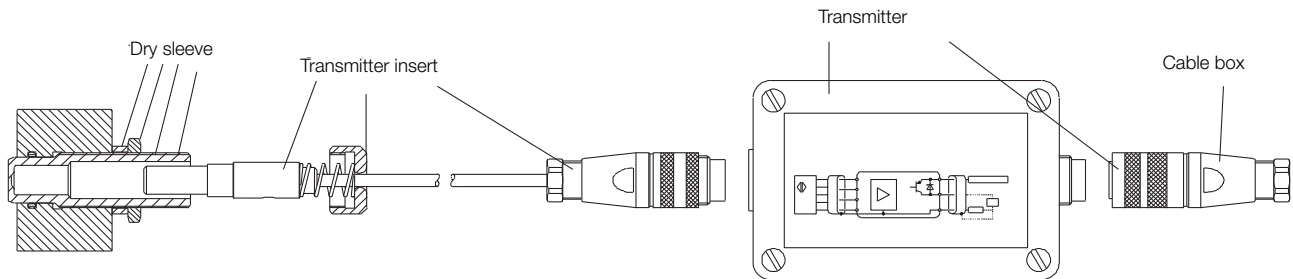

Selection Table for Pulse Generators

Order No.	System	Voltage	t _{max}	p _{max} face	Material Dry sleeve	electrical connection	Protection
OMG.../43	Induktive PNP	10...30 V _{DC}	-20...+100°C (-25...+90°C)*	250 bar	Arcap/ceramics	Right-angle plug with LED and 3 m cable	IP 65
OMK.../46	Induktive PNP	10...30 V _{DC}	-20...+100°C (-25...+90°C)*	40 bar	1.4401/ceramics	Right-angle plug with LED and 3 m cable	IP 65
OMG.../44 OMH.../44	Hall-effect PNP	10...30 V _{DC}	-40...+150°C	420 bar	Arcap	3 m PTFE cable	IP 67
OMG.../45 OMH.../45	Magnetic PNP	10...30 V _{DC}	-40...+250°C (0...+50°C)**	420 bar	Arcap	Cable box/ 1 m PTFE cable	IP 65
OM.../47	Induktive Namur	5...25 V _{DC}	-25...+100°C	40 bar	1.4401/ceramics	2 m PVC cable EEx ia IIC T6	IP 68

* connector
** transmitter



Dimensions

Model OMG-15...

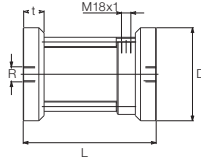

Model OMG-20.../OMG-25...

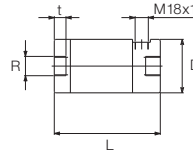

Model	Pipe thread						Model	Pipe thread					
	R [inch]	p [bar]	L [mm]	D [mm]	t [mm]	m [kg]		R [inch]	p [bar]	L [mm]	D [mm]	t [mm]	m [kg]
OMG 15	1/2"	250	145	90	16	4,6	OMG 20	3/4"	250	145	74	16	4,1
							OMG 25	1"	250	215	104	18	11

Model OMG-40.../OMG-50.../OMG-100...

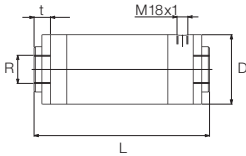

Model OMK-15.../OMK-20.../OMK-25...

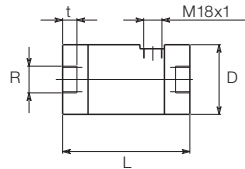

Model	Pipe thread						Model	Pipe thread					
	R [inch]	p [bar]	L [mm]	D [mm]	t [mm]	m [kg]		R [inch]	p [bar]	L [mm]	D [mm]	t [mm]	m [kg]
OMG 40	1 1/2"	160	295	118	27,5	18	OMK 15	1/2"	40	110	59	14	2,0
OMG 50	2"	100	355	138	30	29	OMK 20	3/4"	40	125	69	14	3,0
OMG 100	4"	40	480	188	40	70	OMK 25	1"	40	180	104	18	11

Model OMK-40.../OMK-50...

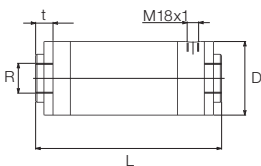

Model OMH-13.../OMH-20.../OMH-25...

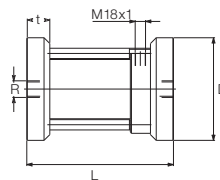

Model	Pipe thread						Model	Pipe thread					
	R [inch]	p [bar]	L [mm]	D [mm]	t [mm]	m [kg]		R [inch]	p [bar]	L [mm]	D [mm]	t [mm]	m [kg]
OMK 40	1 1/2"	40	295	118	27,5	18	OMH 15	1/2"	420	150	100	28	7
OMK 50		40	355	138	30	29	OMH 20	3/4"	420	185	145	35	13
							OMH 25	1"	420	255	180	40	27

Model OMH-40.../OMH-50...

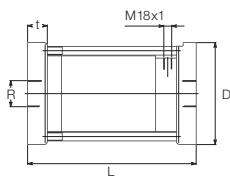

Model OMH-100...

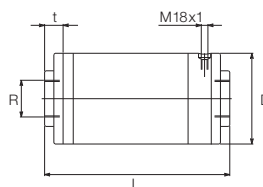

Model	Pipe thread						Model	Pipe thread					
	R [inch]	p [bar]	L [mm]	D [mm]	t [mm]	m [kg]		R [inch]	p [bar]	L [mm]	D [mm]	t [mm]	m [kg]
OMH 40	1 1/2"	420	320	220	40	57	OMH 100	4"	250	500	247	50	135
OMH 50	2"	420	385	235	45	76							