

Diaphragm Seals for Pressure Gauges

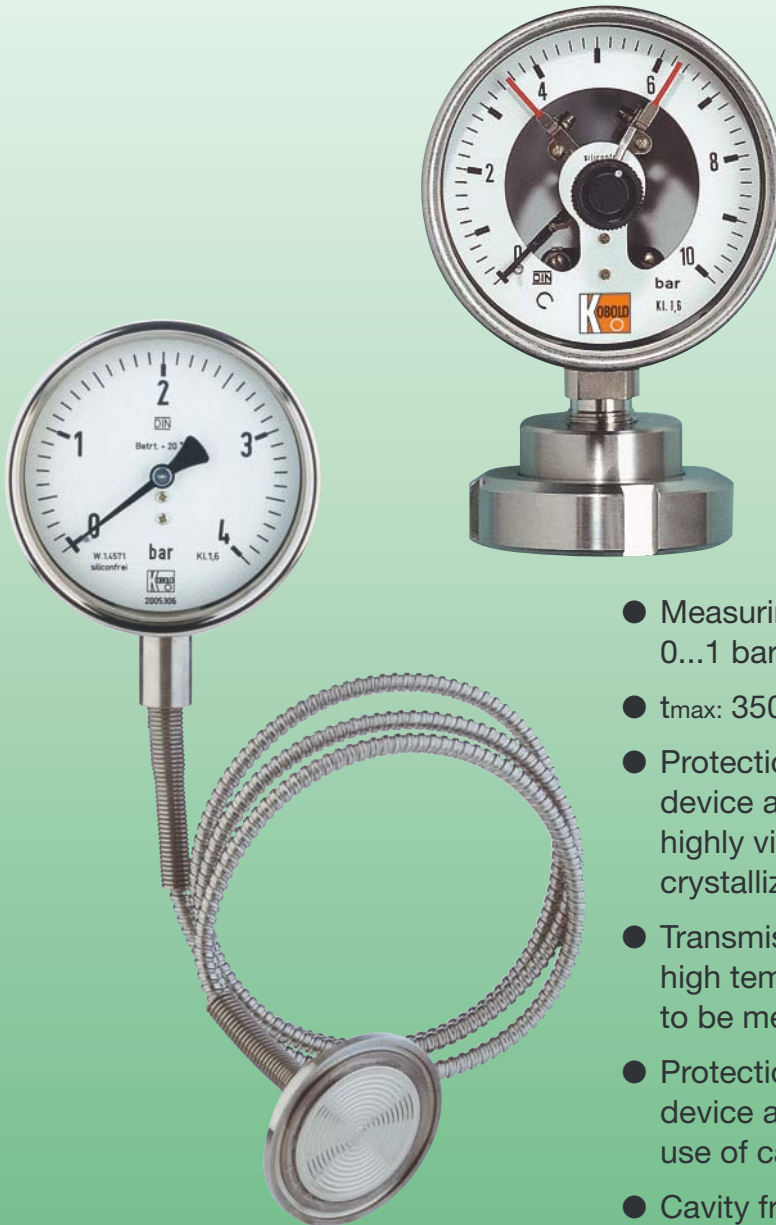

- Measuring ranges:
0...1 bar to 0...1600 bar
- t_{max} : 350 °C
- Protection of the measuring device against aggressive, highly viscous, solidifying or crystallizing media
- Transmission lines enable high temperatures of the media to be measured
- Protection of the measuring device against vibrations by use of capillary tube
- Cavity free measuring points for special hygienic conditions
- Damping of pressure changes and pressure peaks



KOBOLD companies worldwide:

ALGERIA, ARGENTINA, AUSTRALIA, AUSTRIA, BELGIUM, BULGARIA, CANADA, CHILE, CHINA, COLOMBIA, CZECH REPUBLIC, DOM. REPUBLIC, EGYPT, FRANCE, GERMANY, INDIA, INDONESIA, IRAN, ITALY, MALAYSIA, MEXICO, MOROCCO, NETHERLANDS, PERU, POLAND, SINGAPORE, SLOVAKIA, SPAIN, SWITZERLAND, THAILAND, TUNESIA, UNITED KINGDOM, USA, VENEZUELA, VIETNAM

KOBOLD Messing GmbH
 Nordring 22-24
 D-65719 Hofheim/Ts.
 ☎ +49(0)61 92 299-0
 Fax +49(0)61 92 23398
 E-Mail: info.de@kobold.com
 Internet: www.kobold.com

Model:
 DRM



Description

Diaphragm seals are partitions for pressure gauges that prevent the material being measured penetrating the measuring system. For measuring pressure in the food industry the use of diaphragm seals are mostly indispensable. With the right choice of diaphragm seal systems it is possible to solve measuring problems that can often not be overcome with the pressure gauge alone.

Application

KOBOLD membrane diaphragm seals are used when the pressure gauge cannot stand up to the requirements of the measuring position. Diaphragm seals transmit the pressure to be measured over that of the transmission fluid that is separated from the medium to be measured by means of the membrane. The transmitted pressure affects the pressure gauge, pressure switch or pressure sensor. The diaphragm seals can be connected to the pressure gauge either directly, or indirectly using a transmission line. Diaphragm seal and pressure gauge are joined together at the works to create one unit. Assembly and adjustment are carried out with extreme precision and years of experience.

Areas of application:

- Media enriched with solids
- Crystallising measured medium
- Polymerising measured medium
- High viscosity measured medium
- Corrosive measured medium
- Toxic and environmentally hazardous measured medium
- Very low measured medium temperature
- Very high measured medium temperature
- Hygienic requirements for the food and pharmaceutical sector
- Batch changing without product residues in the measuring system

Construction Type

We mainly manufacture diaphragm seals with every conceivable connecting system. Tongue and Bourdon diaphragm seals fill the gaps to cover all the requirements of the measuring point. KOBOLD diaphragm seals cover every type of assembly, whether with internal or external screw thread, or with coupling rings, clamp or flange mounting. Our tongued diaphragm seals are used when the measuring point only provides a very restricted space. Our Bourdon diaphragm seals measure the pressure within the pipe through which the measured medium flows. The type of construction means that the diaphragm seal can be kept very sterile. We are constantly developing new diaphragm seals and improving our existing models.

Characteristics

A diaphragm seal barely influences the characteristics of a pressure gauge. The following items do influence them:

Fill and work volumes

The diaphragm seals only contain the minimum amount of pressure transmission fluid required for temperature and pressure. This volume covers what is needed for the pressure gauge, the compressibility and the thermal expansion.

Membrane

The membranes used are optimally coordinated with the corresponding diaphragm seals.

Transmission line

Reduced volume transmission lines are used to keep the influence on the measuring system as small as possible. Transmission lines are however indispensable for high measured media temperatures, pressure or system pulsation or for unfavourably positioned measuring points.

Pressure transmission fluid

The pressure transmission fluid transmits the pressure from diaphragm seal to pressure gauge. There are various fluids that can be used, depending on the operational conditions. All these fluids fulfil the requirement for minimum compressibility and lowest thermal expansion. Glycerine (up to +80 °C) and liquid paraffin (from -10 to +120 °C) are used as silicon-free fluids. Silicon oils are available for temperature ranges from -40 to +200 °C, -20 to +350 °C and -20 to +400 °C. For special applications we can also fill the gauges with MF7 (Hg, -20 to +350 °C).

In the choice of fluid not all factors can be taken into consideration because, depending on the application, other requirements have to be met, such as food safety specs or that they must be absolutely silicon-free. Our process technicians can choose the best pressure transmission fluid for the requirements.

Operating conditions

Since the proper pressure indication depends on the temperature of the fill fluid the pressure gauge with diaphragm seals can be adjusted for the operating conditions. To keep these errors to a minimum, the measuring systems are configured to suit the ambient and measured medium temperatures of the application. Without readings the gauges are as standard calibrated to a temperature of +20 °C (±2 °C). Gauges with a transmission line are set without a height differential between gauge and diaphragm seal. Other height differentials must be stated when ordering because this greatly influences the accuracy of measurement, especially within small measuring ranges.

Materials

All diaphragm seals are made of 1.4571 or 1.4404 stainless steel, as a matter of principle. Other materials can however be used for the membranes or the whole diaphragm seal. It is also possible to coat the diaphragm or the whole diaphragm seal – for example with PFA.

Accessories are listed as of Page 92.

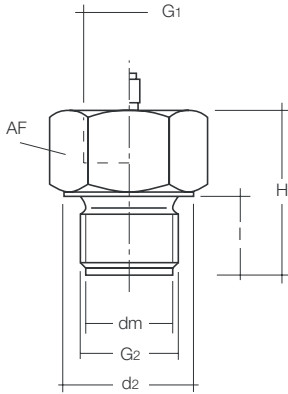

Diaphragm Seal DRM-600 / 601 with fixed male thread

Measuring range: 0 - 6 bar to 0 - 1600 bar (with pressure sensors also smaller)
 Temperature range: -40°C to +200°C
 Material: stainless steel 1.4301, st. steel 1.4571, other upon request
 Diaphragm: flush mounted, stainless steel 1.4571
 Max. length of capillary tube: up to 15 m, if required with armour
 Filling liquid: following operating conditions

Model for direct mounting	Model for capillary tube	G2	G1	dm	AF	d2	l	Hmax	Pressure range [bar]	
									min.	max.
DRM-600 R15	DRM-601 R15	G 1/2 AG	G 1/2	18	27	27	20	42	0-100	0-1000
DRM-600 R20	DRM-601 R20	G 3/4 AG	G 1/2	23.8	36	36	20	46	0-40	0-1000
DRM-600 R25	DRM-601 R25	G 1 AG	G 1/2	29.5	41	40.5	20	46	0-10	0-600
DRM-600 R32	DRM-601 R32	G 1 1/4 AG	G 1/2	38	50	49.5	20	46	0-6	0-600
DRM-600 R40	DRM-601 R40	G 1 1/2 AG	G 1/2	40	60	59.5	20	46	0-6	0-600
DRM-600 N15	DRM-601 N15	1/2 NPT AG	G 1/2	18	27	27	20	42	0-100	0-1000
DRM-600 N20	DRM-601 N20	3/4 NPT AG	G 1/2	18	32	-	20	46	0-40	0-1000
DRM-600 N25	DRM-601 N25	1 NPT AG	G 1/2	23.8	36	-	20	46	0-10	0-600
DRM-600 N32	DRM-601 N32	1 1/4 NPT AG	G 1/2	34.5	41	-	20	46	0-6	0-600
DRM-600 M20	DRM-601 M20	M20x1.5 AG	G 1/2	18	27	27	20	46	0-100	0-600
DRM-600 M48	DRM-601 M48	M48x3 AG	G 1/2	40	60	59.5	20	46	0-6	0-600

100°C	200°C	max. medium temperature
-------	-------	-------------------------

Welding sleeve for DRM-600 / 601

Model	Connection	Hight	Version
MZB-R15 A1	G 1/2 IG	15 mm	PN 100
MZB-R15 A3	G 1/2 IG	34 mm	PN 100
MZB-R20 A1	G 3/4 IG	16.5 mm	PN 100
MZB-R20 A3	G 3/4 IG	36 mm	PN 100
MZB-R25 A1	G 1 IG	19 mm	PN 100
MZB-R25 A4	G 1 IG	43 mm	PN 100
MZB-R32 A2	G 1 1/4 IG	22 mm	PN 100
MZB-R32 A4	G 1 1/4 IG	48 mm	PN 100
MZB-R32 D4	G 1 1/4 IG	48 mm	PN 600
MZB-R40 A2	G 1 1/2 IG	22 mm	PN 100
MZB-R40 A4	G 1 1/2 IG	48 mm	PN 100

Seal for DRM-600 / 601

Model	Material	Seize
MZB-DCU R25	Copper	for G 1
MZB-DCU R32	Copper	for G 1 1/4
MZB-DHD R20	Metal + NBR	for G 3/4
MZB-DHD R25	Metal + NBR	for G 1
MZB-DHD R32	Metal + NBR	for G 1 1/4

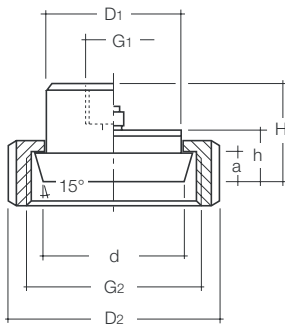

Diaphragm Seal DRM-602 / 603 with union nut according to DIN 11851 (sanitary connection)

Measuring range: 0 - 1 bar to 0 - 40 bar (depending on nominal size)
 Temperature range: -10 °C to +200 °C (not with electr. transmitter)
 Material: st. steel 1.4301, st. steel 1.4571, others on request
 Diaphragm: flush mounted, st. steel 1.4571
 Max. length of capillary tube: up to 10 m, if required with if required with protection hose
 Filling fluid: compatible with foodstuffs

Model for direct mounting	Model for capillary tube	G2	D1	D2	G1	DN	d	a	h	H
DRM-602 R20	-	Rd44 x 1/6"	30	54	G 1/2	20	32	8	16	31
DRM-602 R25	DRM-603 R25	Rd52 x 1/6"	35	63	G 1/2	25	40	8	16	31
DRM-602 R32	DRM-603 R32	Rd58 x 1/6"	70	70	G 1/2	32	46	11	16	32
DRM-602 R40	DRM-603 R40	Rd65 x 1/6"	48	78	G 1/2	40	52	11	16	32
DRM-602 R50	DRM-603 R50	Rd78 x 1/6"	61	92	G 1/2	50	64	11	16	32
DRM-602 R65	DRM-603 R65	Rd95 x 1/6"	79	112	G 1/2	65	84	13	16	32
DRM-602 R80	DRM-603 R80	Rd110 x 1/4"	93	127	G 1/2	80	96	13	16	32
DRM-602 R1H	DRM-603 R1H	Rd130 x 1/4"	114	148	G 1/2	100	117	13	16	32

100 °C	200 °C	max. medium temperature
--------	--------	-------------------------

Diaphragm Seal DRM-602G with round thread according to DIN 11851 (for counterpiece with union nut)

Model for direct mounting	Model for capillary tube	G2	D1	D2*	G1	DN	d**	a	h	H
DRM-602 G25	-	Rd52 x 1/6"	30	(63)	G 1/2	25	43	11	16	32
DRM-602 G32	-	Rd58 x 1/6"	32	(70)	G 1/2	32	49	11	16	32
DRM-602 G40	-	Rd65 x 1/6"	38	(78)	G 1/2	40	55	11	16	32
DRM-602 G50	-	Rd78 x 1/6"	50	(92)	G 1/2	50	64	11	16	32

max. medium temperature 100 °C *D2 = existing on customer side only **d = start of cone of thread connection

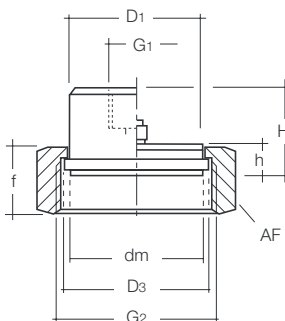

Diaphragm Seal DRM-604 / 605 with union nut acc. to IDF standard

Measuring range: 0 - 1 bar to 0 - 100 bar (depending on nominal size)
 Temperature range: -10 °C to +200 °C (not with electr. transmitter)
 Material: st. steel 1.4301, st. steel 1.4571, others on request
 Diaphragm: front flush, st. steel 1.4571
 Max. length of capillary tube: up to 10 m, if required with protection hose
 Filling fluid: compatible with foodstuffs

Model for direct mounting	Model for capillary tube	G2IDF	D1, dm	D3	G1	AF	f	h	H
DRM-604 R55	DRM-605 R25	1"	29.5	33.5	G 1/2	47	30	13	31
DRM-604 R40	DRM-605 R40	1 1/2"	42.5	47	G 1/2	62	30	13	30.5
DRM-604 R50	DRM-605 R50	2"	56	60	G 1/2	77	30	13	30.5

100 °C	200 °C	max. medium temperature
--------	--------	-------------------------

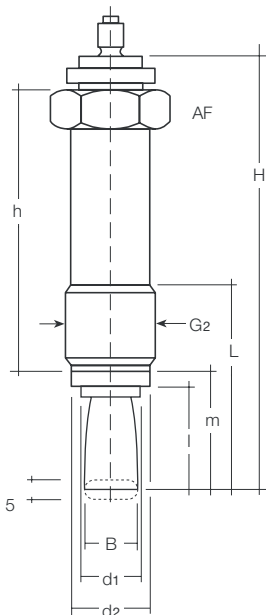

**Capsule seal DRM-606, 33 cm long,
standard with running nut G^{3/4} A, M28x1.5**
for capillary connection

Measuring range: 0 - 100 bar to 0 - 600 bar
 Temperature range: -40 °C to +350 °C
 Material: st. steel 1.4571, others on request
 Tongue sensor: st. steel 1.4571
 Max. length of capillary tube: bis 15 m, if required with protection hose
 Filling fluid: MF 7 recommended

Model for capillary tube	AF	G ₂	B	d ₁	d ₂	l	m	L	h	H
DRM-606 R20	32	G ^{3/4} AG	16.5	18	24	33	39	67	76	130
DRM-606 R28	32	M28 x 1.5 AG	16.5	18	24	33	39	67	76	130

350 °C	max. medium temperature									
--------	-------------------------	--	--	--	--	--	--	--	--	--

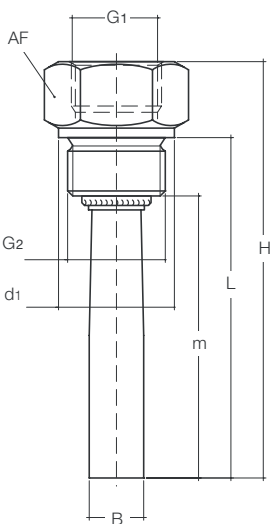

Capsule seal DRM-607 with fixed male thread

Measuring range: 0 - 6 bar to 0 - 600 bar
 Temperature range: -40 °C to +100 °C
 Material: st. steel 1.4301, others on request
 Tongue sensor: st. steel 1.4571
 Max. length of capillary tube: 15 m, if required with protection hose
 Filling fluid: MF 7 recommended

Model for direct mounting	Model for capillary tube	G ₂	AF	B	G ₁	d ₁	m	L	H
DRM-607 R15	-	G ^{1/2} AG	27	16.5	G ^{1/2}	27	94	102	126
DRM-607 R20	-	G ^{3/4} AG	32	16.5	G ^{1/2}	32	94	100	118

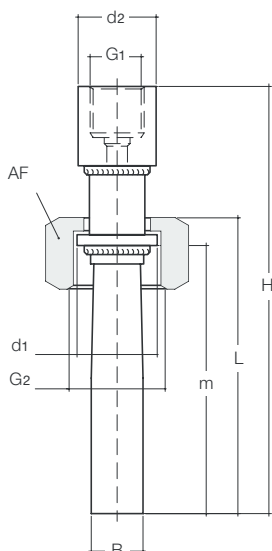

Capsule seal DRM-607 / 1 and DRM-608 / 1 with union nut

Measuring range: 0 - 6 bar to 0 - 600 bar
 Temperature range: -40 °C to +350 °C
 Material: st. steel 1.4301, others on request
 Tongue sensor: st. steel 1.4571
 Max. length of capillary tube: 15 m, if required with protection hose
 Filling fluid: MF 7 recommended

Model for direct mounting	Model for capillary tube	G ₂	AF	B	G ₁	d ₁	d ₂	m	L	H
DRM-607/1 R20	DRM-608/1 R20	G ^{3/4} IG	32	16.5	G ^{1/2}	23,5	25	85	94	132
DRM-607/1 R25	DRM-608/1 R25	G 1 IG	36	16.5	G ^{1/2}	29	25	85	94	132

100 °C	350 °C	max. medium temperature								
--------	--------	-------------------------	--	--	--	--	--	--	--	--

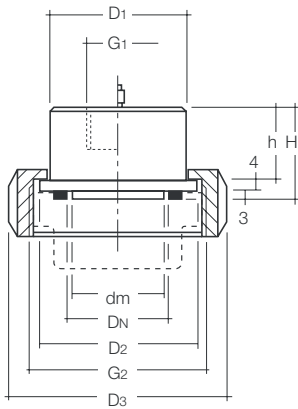

Diaphragm Seal DRM-610/611 with union nut to SMS standard

Measuring range: 0 - 1 bar to 0 - 10 bar (depending on nominal size)
 Temperature range: -10°C to +200°C (not with electr. transmitter)
 Material of housing: st. steel 1.4571, others on request
 Diaphragm: front flush, st. steel 1.4571
 Max. length of capillary tube: up to 10 m, if required with protection hose
 Filling fluid: compatible with foodstuffs

Model for direct mounting	Model for capillary tube	G2 SMS-standard	D1	D2	dm	G1	DN	D3	h	H
DRM-610 R40	DRM-611 R40	1 1/2"	47.5	55	34.5	G 1/2	1 1/2"	74	20	27
DRM-610 R50	DRM-611 R50	2"	60	65	45.5	G 1/2	2"	84	20	27

100°C	200°C	max. medium temperature
-------	-------	-------------------------

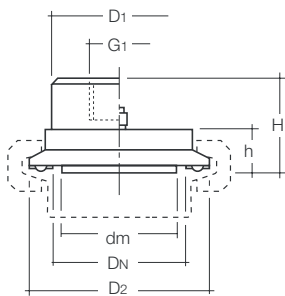

Diaphragm Seal DRM-612/613 with clamp connection

Measuring range: 0 - 2.5 bar to 0 - 10 bar
 Temperature range: -10°C to +200°C (not with electr. transmitter)
 Material of housing: st. steel 1.4571, others on request
 Diaphragm: front flush, st. steel 1.4571
 Max. length of capillary tube: up to 10 m, if required with protection hose
 Filling fluid: compatible with foodstuffs

Model for direct mounting	Model for capillary tube	DN	D1	D2	dm	G1	h	H
DRM-612 R25	DRM-613 R25	1"	42.5	50.5	18	G 1/2	10.5	25
DRM-612 F40	DRM-613 F40	1 1/2"	42.5	50.4	34.5	G 1/2	10.5	25
DRM-612 F50	DRM-613 F50	2"	51	64	45.5	G 1/2	10.5	25
DRM-612 R65	DRM-613 R65	2 1/2"	63.5	77.5	52	G 1/2	10.5	25
DRM-612 R80	DRM-613 R80	3"	76	91	64	G 1/2	10.5	25

100°C	200°C	max. medium temperature
-------	-------	-------------------------

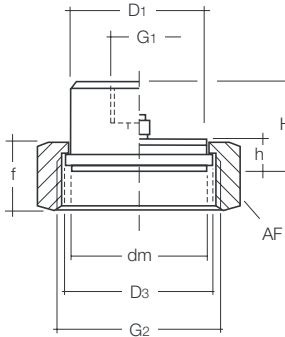

Diaphragm seal DRM-614 / 615 with union nut to APV-RJT standard

Measuring range: 0 - 1 bar to 0 - 100 bar (depending on nominal size)
 Temperature range: - 10°C to +200°C (not with electr. transmitter)
 Material of housing: st. steel 1.4571, others on request
 Diaphragm: front flush, st. steel 1.4571
 Max. length of capillary tube: up to 10 m, if required with protection hose
 Filling fluid: compatible with foodstuffs

Model for direct mounting	Model for capillary tube	G2 APV-RJT	D1, dm	D3	G1	AF	f	h	H
DRM-614 R25	DRM-615 R25	1"	29.5	33.5	G 1/2	47	30	13	31
DRM-614 R40	DRM-615 R40	1 1/2"	42.5	47	G 1/2	62	30	13	30.5
DRM-614 R50	DRM-615 R50	2"	56	60	G 1/2	77	30	13	30.5

100°C	200°C	max. medium temperature
-------	-------	-------------------------

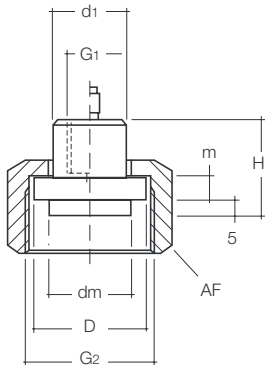

Diaphragm seal DRM-616 / 617 with union nut

Measuring range: 0 - 100 bar to 0 - 1600 bar
 Temperature range: 0°C to +120°C (not with electr. transmitter)
 Material of housing: st. steel 1.4571
 Diaphragm: front flush, st. steel 1.4571
 Max. length of capillary tube: up to 10 m, if required with protection hose
 Filling fluid: MF 8 (foodstuff-compatible) recommended

Model for direct mounting	Model for capillary tube	G2	G1	AF	dm	D	d1	m	H
DRM-616 R45	DRM-617 R45	M45x2	G 3/8	55	23.8	33.3	22	6	27

100°C	120°C	max. medium temperature
-------	-------	-------------------------

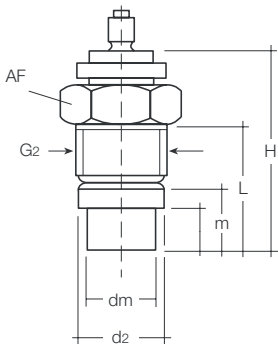

Diaphragm seal DRM-620, Ø 18 mm, rotatable with running nut for connection of capillary tube

Measuring range: 0 - 100 bar to 0 - 600 bar
 Temperature range: 0°C to +350°C (not with electr. transmitter)
 Material of housing: st. steel 1.4571, others on request
 Diaphragm: front flush, st. steel 1.4571
 Max. length of capillary tube: up to 10 m, if required with protection hose
 Filling fluid: MF 7 recommended

Model for capillary tube	G2	dm	d2	AF	l	m	L	H
DRM-620 R20	G 3/4 AG	18	23.8	32	11	17	35	60

350°C	max. medium temperature
-------	-------------------------

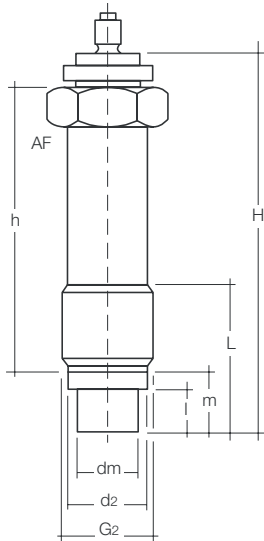

Diaphragm seal DRM-620/1, Ø 18 mm, rotatable, long

with running nut for connection of capillary tube

Measuring range: 0 - 100 bar to 0 - 600 bar
 Temperature range: 0°C to +350°C
 Material of housing: st. steel 1.4571, others on request
 Diaphragm: front flush, st. steel 1.4571
 Max. length of capillary tube: up to 10 m, if required with protection hose
 Filling fluid: MF 7 recommended

Model for capillary tube	G2	dm	d2	AF	l	m	L	H	H
DRM-620/1 R20	G 3/4 AG	18	23.8	32	11	17	45	76	107

350°C	max. medium temperature
-------	-------------------------

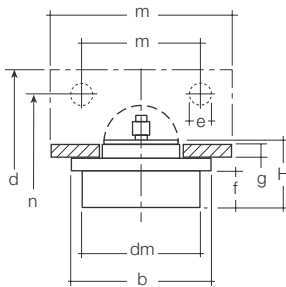

Diaphragm seal DRM-621, Ø 38 mm, rotatable

with rectangular flange for capillary connection

Measuring range: 0 - 4 bar to 0 - 25/40 bar
 Temperature range: -20°C to +250°C (not with electr. transmitter)
 Material of housing: st. steel 1.4571, others on request
 Diaphragm: front flush, st. steel 1.4571
 Rectangle flange: material: passivated steel
 Max. length of capillary tube: up to 12 m, if required with protection hose
 Filling fluid: depending on operating conditions

Model for capillary tube	dm	b	c	d	e	f	g	H	m	n
DRM-621 F38	38	45	58	50	6.5	12	6	25	45	35

250°C	max. medium temperature
-------	-------------------------

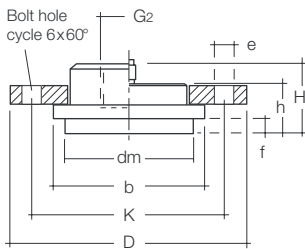

Diaphragm seal DRM-622 Ø 48 mm with mounting flange

Measuring range: vacuum, 0 - 4 bar to 0 - 25/40 bar
 Temperature range: -20 °C to +200 °C
 Material of housing: st. steel 1.4571, others on request
 Diaphragm: front flush, st. steel 1.4571
 Flange: Ø 85 mm, material: passivated steel, 1.4571, aluminium
 Max. length of capillary tube: up to 15 m, if required with protection hose
 Filling fluid: depending on operating conditions

Model for direct mounting	Model for capillary tube	dm	b	D	K	e	f	h	H	G ₁
DRM-622 F48	DRM-622/1 F48	48	58	85	70	7	6.5	18	25	G 1/2
DRM-622 F48 1	DRM-622/1 F48 1	48	58	85	70	7	18	29.5	36.5	G 1/2
DRM-622 F48 2	DRM-622/1 F48 2	48	58	85	70	7	44	55.5	62.5	G 1/2

100 °C	200 °C	max. medium temperature
--------	--------	-------------------------

Seal for DRM-622 F48

Model	Material
MZB-D T1F48	PTFE
MZB-D P1F48	Paper

**Counter flange DRM-622
Model: MZB-G DRM622**

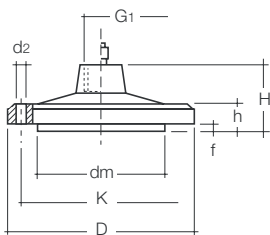

Diaphragm seal with flange connection DRM-624 Ø 100 mm

Measuring range: 0 - 1 bar to 0 - 40 bar
 Temperature range: -40 °C to +250 °C
 Material of housing: st. steel 1.4571, others on request
 Diaphragm: front flush, st. steel 1.4571
 Max. length of capillary tube: up to 15 m, if required with protection hose
 Filling fluid: depending on operating conditions

Model for direct mounting	Model for capillary tube	G ₁	dm	K	d ₂	D	f	b	H
DRM-624 F1H	DRM-624/1 F1H	G 1/2	63.5	82	7	100	2	8	34.5
DRM-624 F1H T (PTFE-coating)	-	G 1/2	63.5	82	7	100	2	8	34.5

100 °C	250 °C	max. medium temperature
--------	--------	-------------------------

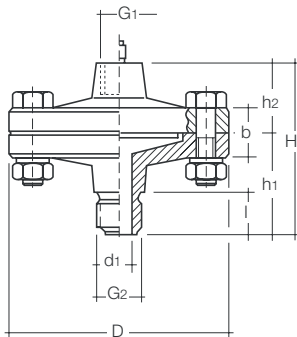

Diaphragm seal DRM-625 with connection G 1/2 and enlarged bore, Ø 10 mm

Measuring range: 0 - 1 bar to 0 - 40 bar (depending on nominal size)
 Temperature range: -40 °C to +250 °C
 Material of housing: st. steel 1.4571, others on request
 Diaphragm: front flush, st. steel 1.4571
 Max. length of capillary tube: up to 10 m, if required with protection hose
 Filling fluid: depending on operating conditions

Model for direct mounting	Model for capillary tube	D	G1	G2	d1	b	l	h1	h2	H
DRM-625 R15	DRM-625/1 R15	100	G 1/2 IG	G 1/2 AG	10	18	20	46	34.5	80.5
DRM-625 N15	DRM-625/1 N15	100	G 1/2 IG	1/2 NPT AG	10	18	20	46	34.5	80.5
DRM-625 I15	DRM-625/1 I15	100	G 1/2 IG	G 1/2 IG	10	18	20	46	34.5	80.5

100 °C	250 °C	max. medium temperature
--------	--------	-------------------------

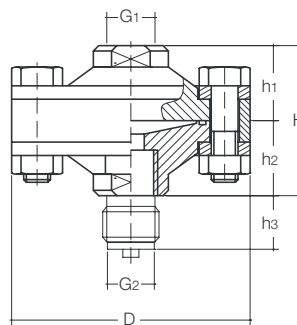

Diaphragm seal DRM-626 / 627 Vario, Ø 90 mm

Meas. range pressure gauge: 0 - 2.5 bar to 0 - 250 bar
 Meas. range sensor: 0 - 0.6 bar to 0 - 250 bar
 Temperature range: -40 °C to +250 °C
 Material for body: st. steel 1.4571, others on request
 Material for assembly elements: galvanised steel (optional st. steel 1.457)
 Material for O-ring: FPM
 Material diaphragm: st. steel 1.4571, st. steel 1.4571 with PFA-coating, Tantal, Monel, others on request
 Max. length of capillary tube: up to 10 m, if required with protection hose
 Filling fluid: depending on operating conditions

Model for direct mounting	Model for capillary tube	D	G1	G2	H	H1	H2	H3	PN [bar]
DRM-626 R08 A025	DRM-627 R08 A025	90	G 1/2	G 1/4 AG	56	28	28	15	25
DRM-626 R08 I025	DRM-627 R08 I025	90	G 1/2	G 1/4 IG	56	28	28	-	25
DRM-626 R15 A025	DRM-627 R15 A025	90	G 1/2	G 1/2 AG	56	28	28	20	25
DRM-626 R15 I025	DRM-627 R15 I025	90	G 1/2	G 1/2 IG	56	28	28	-	25
DRM-626 N15 A025	DRM-627 N15 A025	90	G 1/2	1/2 NPT AG	56	28	28	20	25
DRM-626 R08 A100	DRM-627 R08 A100	90	G 1/2	G 1/4 AG	56	28	28	15	100
DRM-626 R08 I100	DRM-627 R08 I100	90	G 1/2	G 1/4 IG	56	28	28	-	100
DRM-626 R15 A100	DRM-627 R15 A100	90	G 1/2	G 1/2 AG	56	28	28	20	100
DRM-626 R15 I100	DRM-627 R15 I100	90	G 1/2	G 1/2 IG	56	28	28	-	100
DRM-626 N15 A100	DRM-627 N15 A100	90	G 1/2	1/2 NPT AG	56	28	28	20	100
DRM-626 R08 A250	DRM-627 R08 A250	90	G 1/2	G 1/4 AG	56	28	28	15	250
DRM-626 R08 I250	DRM-627 R08 I250	90	G 1/2	G 1/4 IG	56	28	28	-	250
DRM-626 R15 A250	DRM-627 R15 A250	90	G 1/2	G 1/2 AG	56	28	28	20	250
DRM-626 R15 I250	DRM-627 R15 I250	90	G 1/2	G 1/2 IG	56	28	28	-	250
DRM-626 N15 A250	DRM-627 N15 A250	90	G 1/2	1/2 NPT AG	56	28	28	20	250

100 °C	250 °C	max. medium temperature pressure gauges
80 °C	250 °C	max. medium temperature pressure sensors

Assembly type up to 25 bar:
4 screws

Assembly type up to 100 bar:
4 screws, supporting ring

Assembly type up to 250 bar:
8 screws, supporting ring

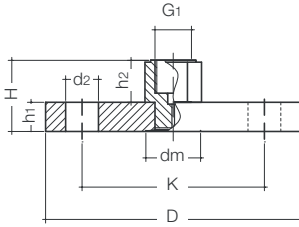

Diaphragm seal with flange connection DRM-628 / 629 to DIN with sealed-in membrane

Meas. range pressure gauge: 0 - 1.0 bar to 0 - 40 bar*
 Meas. range sensor: 0 - 0.25 bar to 0 - 40 bar*
 *(depending on PN and DN of flange)
 Temperature range: -40°C to +250°C
 Material flange: st. steel 1.4571, others on request
 Material diaphragm: st. steel 1.4571, others on request
 Coating: PFA-coating on request
 Max. length of capillary tube: up to 10 m, if required with protection hose
 Filling fluid: depending on operating conditions
 Connection device: G 1/2 female thread (G1)

Model for direct mounting	Model for capillary tube	DN	D	K	d2	H	h1	h2	dm	P1 min [bar]	P2 min [bar]	PN
DRM-628 F25 P06	DRM-629 F25 P06	25	100	75	11	37	14	23	24	2.5	-	6
DRM-628 F32 P06	DRM-629 F32 P06	32	120	90	14	37	14	23	30	1.6	-	6
DRM-628 F40 P06	DRM-629 F40 P06	40	130	100	14	37	14	23	38	1.0	4	6
DRM-628 F50 P06	DRM-629 F50 P06	50	140	110	14	37	14	23	48	0.6	2.5	6
DRM-628 F65 P06	DRM-629 F65 P06	65	160	130	14	37	14	23	64	0.25	1.0	6
DRM-628 F80 P06	DRM-629 F80 P06	80	190	150	18	39	16	23	64	0.25	1.0	6
DRM-628 F1H P06	DRM-629 F1H P06	100	210	170	18	39	16	23	64	0.25	1.0	6
DRM-628 F25 P16	DRM-629 F25 P16	25	115	85	14	39	16	23	24	2.5	-	16
DRM-628 F32 P16	DRM-629 F32 P16	32	140	100	18	39	16	23	30	1.6	6	16
DRM-628 F40 P16	DRM-629 F40 P16	40	150	110	18	39	16	23	38	1.0	4	16
DRM-628 F50 P16	DRM-629 F50 P16	50	165	125	18	41	18	23	48	0.6	2.5	16
DRM-628 F65 P16	DRM-629 F65 P16	65	185	145	18	41	18	23	64	0.25	1.0	16
DRM-628 F80 P16	DRM-629 F80 P16	80	200	160	18	43	20	23	64	0.25	1.0	16
DRM-628 F1H P16	DRM-629 F1H P16	100	220	180	18	43	20	23	64	0.25	1.0	16
DRM-628 F25 P40	DRM-629 F25 P40	25	115	85	14	41	18	23	24	2.5	25	40
DRM-628 F32 P40	DRM-629 F32 P40	32	140	100	18	41	18	23	30	1.6	6	40
DRM-628 F40 P40	DRM-629 F40 P40	40	150	110	18	41	18	23	38	1.0	4	40
DRM-628 F50 P40	DRM-629 F50 P40	50	165	125	18	43	20	23	48	0.6	2.5	40
DRM-628 F65 P40	DRM-629 F65 P40	65	185	145	18	45	22	23	64	0.25	1.0	40
DRM-628 F80 P40	DRM-629 F80 P40	80	200	160	18	47	24	23	64	0.25	1.0	40
DRM-628 F1H P40	DRM-629 F1H P40	100	235	190	22	47	24	23	64	0.25	1.0	40

100°C	250°C	max. medium temperature pressure gauge
80°C	250°C	max. medium temperature pressure sensor

P1 = Mounting of pressure sensors
 P2 = Mounting of pressure gauge

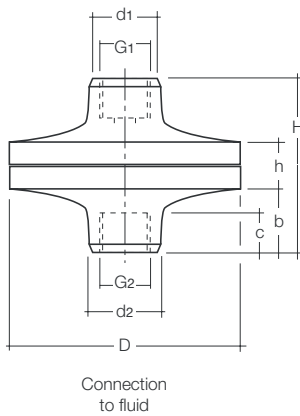

Diaphragm seal DRM-630 / 631 from plastic

Measuring range: 0 - 1.6 bar to 0 - 10 bar
 Temperature range: 0°C to +250°C
 Material housing: PVC (Polyvinylchlorid), PP (Polypropylene)
 Diaphragm: Hypalon with PTFE-coating (others on request)
 Filling fluid: depending on operating conditions

Model for direct mounting	Model for capillary tube	Material	D	G1	G2	d1	d2	b	c	h	H
DRM-630 R08	DRM-630/1 R08	PVC	90	G 1/4	G 1/4	32	32	25	18	24	75
DRM-630 R15	DRM-630/1 R15	PVC	90	G 1/2	G 1/2	32	32	25	18	34	75
DRM-630 N15	DRM-630/1 N15	PVC	90	1/2 NPT	1/2 NPT	32	32	25	18	34	75
DRM-631 R08	DRM-631/1 R08	PP	90	G 1/4	G 1/4	32	32	25	18	24	75
DRM-631 R15	DRM-631/1 R15	PP	90	G 1/2	G 1/2	32	32	25	18	34	75
DRM-631 N15	DRM-631/1 N15	PP	90	1/2 NPT	1/2 NPT	32	32	25	18	34	75

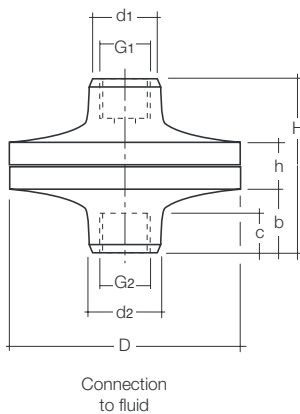

Diaphragm seal DRM-632 from PVDF

Measuring range: 0 - 1.6 bar to 0 - 16 bar
 Temperature range: 0°C to +50°C
 Material housing: PVDF (Polyvinylfluorid)
 Diaphragm: Hypalon with PTFE-coating (others on request)
 Filling fluid: depending on operating conditions

Model for direct mounting	Model for capillary tube	D	G1	G2	d1	d2	b	c	h	H
DRM-632 R08	DRM-632/1 R08	90	G 1/4	G 1/4	32	32	25	18	24	75
DRM-632 R15	DRM-632/1 R15	90	G 1/2	G 1/2	32	32	25	18	34	75
DRM-632 N15	DRM-632/1 N15	90	1/2 NPT	1/2 NPT	32	32	25	18	34	75

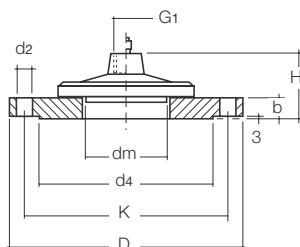

Diaphragm seal with flange connection DRM-633, Ø 100 mm, with open mounting flange DIN 2527 type C

Measuring range: 0 - 1 bar to 0 - 40 bar (0 - 6 bar with DN100)
 Temperature range: -40°C to +250°C
 Material: st. steel 1.4301, st. steel 1.4571, others on request
 Diaphragm: front flush, st. steel 1.4571
 Max. length of capillary tube: bis 15 m, if required with protection hose
 Filling fluid: depending on operating conditions

Model for direct mounting	Model for capillary tube	Flange DN/PN	G1	dm	d4	K	D	d2	b	H
DRM-633 F50	DRM-633/1 F50	50/40	G 1/2	64	102	125	165	18	20	54.5
DRM-633 F1H	DRM-633/1 F1H	100/6	G 1/2	64	148	170	210	18	16	50.5

100°C	250°C	max. medium temperature
-------	-------	-------------------------

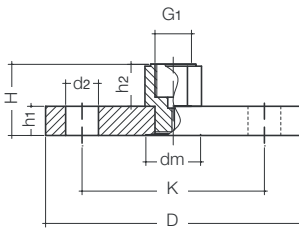

Diaphragm seal with flange connection DRM-634/635 to ANSI B16.5 with sealed-in membrane

Meas. range pressure gauge: 0 - 15 psi to 0 - 1500 psi (0 - 1.0 bar to 0 - 100 bar) depending on PN and DN of flange
 Meas. range sensor: 0 - 4 psi to 0 - 1500 psi (0 - 0.25 bar to 0 - 100 bar) depending on PN and DN of flange
 Temperature range: -40 °C to +250 °C
 Material flange: st. steel 1.4571, others on request
 Material diaphragm: st. steel 1.4571, others on request
 Coating: PFA-coating on request
 Max. length of capillary tube: 10 m, if required with protection hose
 Filling fluid: depending on operating conditions
 Connection device: G 1/2 female thread (G1)

Model for direct mounting	Model for capillary tube	DN	D	K	d2	H	h1	h2	dm	P1 min psi	P2 min psi	PN psi
DRM-634 F25 P150	DRM-635 F25 P150	1"	107.9	79.4	16	37.3	14.3	23	30	25	90	150
DRM-634 F32 P150	DRM-635 F32 P150	1 1/4"	117.5	88.9	16	38.9	15.9	23	38	15	60	150
DRM-634 F40 P150	DRM-635 F40 P150	1 1/2"	127	98.4	16	40.5	17.5	23	38	15	60	150
DRM-634 F50 P150	DRM-635 F50 P150	2"	152.4	120.6	19	42	19	23	48	10	40	150
DRM-634 F65 P150	DRM-635 F65 P150	2 1/2"	177.8	139.7	19	45.2	22.2	23	48	10	40	150
DRM-634 F80 P150	DRM-635 F80 P150	3"	190.5	152.4	19	46.8	23.8	23	64	4	15	150
DRM-634 F90 P150	DRM-635 F90 P150	3 1/2"	215.9	177.8	19	46.8	23.8	23	64	4	15	150
DRM-634 F1H P150	DRM-635 F1H P150	4"	228.6	190.5	19	46.8	23.8	23	64	4	15	150
DRM-634 F25 P300	DRM-635 F25 P300	1"	123.8	88.9	19	40.5	17.5	23	30	25	90	300
DRM-634 F32 P300	DRM-635 F32 P300	1 1/4"	133.3	98.4	19	42	19	23	38	15	60	300
DRM-634 F40 P300	DRM-635 F40 P300	1 1/2"	155.6	114.3	22	43.2	20.6	23	38	15	60	300
DRM-634 F50 P300	DRM-635 F50 P300	2"	165.1	127	19	45.2	22.2	23	48	10	40	300
DRM-634 F65 P300	DRM-635 F65 P300	2 1/2"	190.5	149.2	22	48.4	25.4	23	48	10	40	300
DRM-634 F80 P300	DRM-635 F80 P300	3"	209.5	168.3	22	51.6	28.6	23	64	4	15	300
DRM-634 F90 P300	DRM-635 F90 P300	3 1/2"	228.6	184.1	22	53.2	30.2	23	64	4	15	300
DRM-634 F1H P300	DRM-635 F1H P300	4"	254	200	22	54.7	31.7	23	64	4	15	300
DRM-634 F25 P600	DRM-635 F25 P600	1"	123.8	88.9	19	46.9	23.9	23	30	25	90	600
DRM-634 F32 P600	DRM-635 F32 P600	1 1/4"	133.3	98.4	19	40	27	23	30	15	60	600
DRM-634 F40 P600	DRM-635 F40 P600	1 1/2"	155.6	114.3	22	41.6	28.6	23	38	15	60	600
DRM-634 F50 P600	DRM-635 F50 P600	2"	165.1	127	19	54.8	31.8	23	48	10	40	600
DRM-634 F65 P600	DRM-635 F65 P600	2 1/2"	190.5	149.2	22	58	35	23	48	10	40	600
DRM-634 F80 P600	DRM-635 F80 P600	3"	209.5	168.3	22	61.1	38.1	23	64	4	15	600
DRM-634 F90 P600	DRM-635 F90 P600	3 1/2"	228.6	184.1	25	64.3	41.3	23	64	4	15	600
DRM-634 F1H P600	DRM-635 F1H P600	4"	273	215.9	25	67.5	44.5	23	64	4	15	600
DRM-634 F25 P1K5	DRM-635 F25 P1K5	1"	149.2	101.6	25	58	35	23	30	25	90	1500
DRM-634 F32 P1K5	DRM-635 F32 P1K5	1 1/4"	158.7	111.1	25	58	35	23	38	15	60	1500
DRM-634 F40 P1K5	DRM-635 F40 P1K5	1 1/2"	177.8	123.8	29	61.1	38.1	23	38	15	60	1500
DRM-634 F50 P1K5	DRM-635 F50 P1K5	2"	215.9	165.1	25	67.5	44.5	23	48	10	40	1500
DRM-634 F65 P1K5	DRM-635 F65 P1K5	2 1/2"	244.5	190.5	29	70.7	47.7	23	48	10	40	1500
DRM-634 F80 P1K5	DRM-635 F80 P1K5	3"	266.7	203.2	32	77	54	23	64	4	15	1500
DRM-634 F1H P1K5	DRM-635 F1H P1K5	4"	311.1	241.3	35	83.4	60.4	23	64	4	15	1500

P1 = Mounting of pressure sensors
 P2 = Mounting of pressure gauge

100 °C	250 °C	max. medium temperature pressure gauge
80 °C	250 °C	max. medium temperature pressure sensor

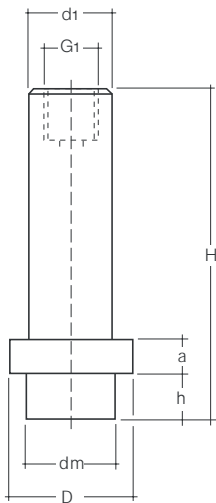

Diaphragm Seals DRM-189 for homogenizing machines, for direct mounting to pressure gauges

Measuring range: 0 - 100 bar to 0 - 1000 bar
 Temperature range: 0°C to + 120°C (calibration temperature +85°C)
 Material housing: st. steel 1.4571
 Diaphragm: front flush, st. steel 1.4571
 Max. length of capillary tube: not available
 Filling fluid: MF 8 (foodstuff-compatible) recommended

Model for direct mounting	D	dm	d1	a	h	H	G1
DRM-189 F23	34.5	23.8	22	10	12.5	90.5	G 3/8

Accessories for pressure gauges

	Material	Code
Protection hose (capillary tube)	W. 1.4301	A
Protection against buckling (capillary tube)	steel	C
Elbow joint	passivated steel	D
Intermediate piece	passivated steel	E
Temperature calibration up to +100°C		G
Temperature calibration from +100°C		H
Special calibration (e. g. height adjustment, 2 temperatures)		I
PTFE-coating		K
Halar-coating		L
Special materials		S
Welded contra flange for measuring adapter 48 mm (DRM-622)		DRM-622 G
Mounting set (screw and sealings)		GRM-ZM1
Mounting set PTFE (VA-screws and PTFE-sealings)		DRM-ZM2

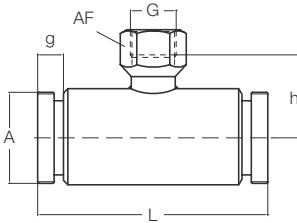

Inline diaphragm seal DRM-500 / 501, sterile connection ISO, for direct mounting and with capillary tube

Measuring range: 1.6 - 40 bar to 2.5 - 40 bar (depending on the pipe dia.)
 Temperature range: up to 80 °C (> 30 min. to 140 °C)
 Housing: st. steel 1.4571
 Diaphragm tube: st. steel 1.4571 (DN 15/20/25/40),
 st. steel 1.4404 resp. 1.4435 (DN 50)
 Socket connection: st. steel 1.4301 (DN 15/20),
 st. steel 1.4435 (DN 25/40/50)
 Filling fluid: depending on operating conditions

Model for direct mounting	Model for capillary tube	DN	A	L	h	G	g	AF
DRM-500 D15	DRM-501 D15	15	M30x2	130	26	G 1/4	12	17
DRM-500 D20	DRM-501 D20	20	M36x2	120	30	G 1/4	12	17
DRM-500 D25	DRM-501 D25	25	M42x2	120	33	G 1/2	12	27
DRM-500 D40	DRM-501 D40	40	M56x2	110	39	G 1/2	14	27
DRM-500 D50	DRM-501 D50	50	M68x2	100	45	G 1/2	14	27

Model for direct mounting	Model for capillary tube	DN	for tube	O-ring	Weight [kg]	Inner form
DRM-500 D15	DRM-501 D15	15	26.9x2.0	18.5x3.0	0.6	square
DRM-500 D20	DRM-501 D20	20	33.7x2.0	25.0x3.0	0.8	square
DRM-500 D25	DRM-501 D25	25	48.3x2.0	30.0x3.0	0.9	hexagonal
DRM-500 D40	DRM-501 D40	40	60.3x2.0	45.0x3.0	1.3	hexagonal
DRM-500 D50	DRM-501 D50	50	88.9x2.0	55.0x3.0	1.6	hexagonal

DN 1/2" - 1"

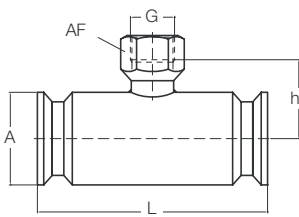

Inline diaphragm seal DRM-502 with clamp connection ISO 2852 for direct mounting

Measuring range: 1.6 - 40 bar to 2.5 - 40 bar (depending on the pipe dia.)
 Temperature range: up to 80 °C (> 30 min. to 140 °C)
 Housing: st. steel 1.4435
 Diaphragm tube: st. steel 1.4435 (DN 15/20/25),
 st. steel 1.4404 (DN 40/50)
 Socket connection: st. steel 1.4301 (DN 15/20/25),
 st. steel 1.4435 (DN 40/50)
 Filling fluid: depending on operating conditions

Model for direct mounting	DN	A	L	h	G	AF	Weight [kg]	Inner form
DRM-502 D15	1/2"	25	140	24	G 1/2	17	0.5	square
DRM-502 D20	3/4"	25	120	27	G 1/2	27	0.5	square
DRM-502 D25	1"	50.5	120	36	G 1/2	27	1.6	square
DRM-502 D40	1 1/2"	50.5	120	36	G 1/2	27	1.2	hexagonal
DRM-502 D50	2"	64	100	45	G 1/2	27	1.3	hexagonal

DN 1 1/2" - 2"

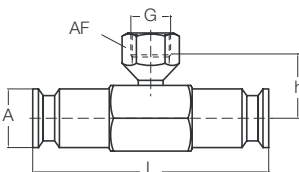



Multipart design

- Very good cooling effect
- Perforated sheet body transmits little heat
- $t_{max} = 450^{\circ}C$
- PN 600 (temperature-dependent)
- All parts are made of 1.4571 stainless steel
- Pressure transmission with a capillary line (inner $\varnothing 1.0$ mm), that in addition balances out the pulsation of the measured pressure
- Also for direct mounting of diaphragm seals ($t_{max} = 350^{\circ}C$)

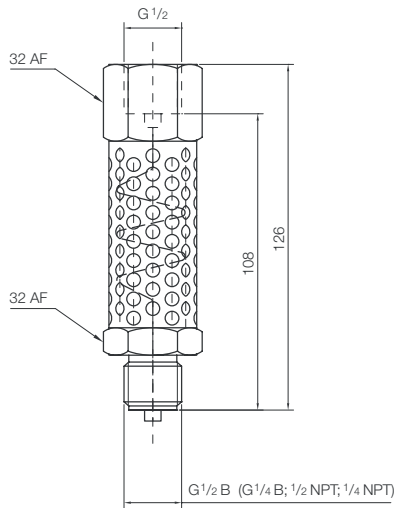

One-part design

- Good cooling effect
- Optimum ration of surface to geometry
- $t_{max} = 300^{\circ}C$
- PN 600 (temperature-dependent)
- Body made of 1.4571 stainless steel
- Pressure transmission with tube diameter (inner $\varnothing 3.5$ mm), thus no change in reaction time
- Cheaper version
- for use with high viscosity media

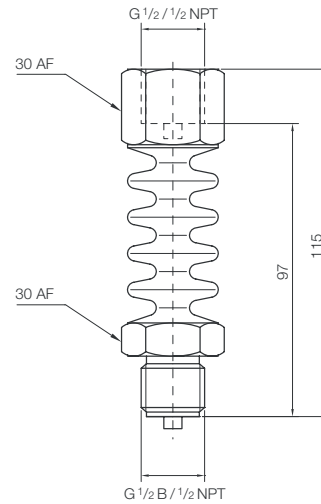

Temperature drift (guide value for cooling effect) and range of use (rated pressure)

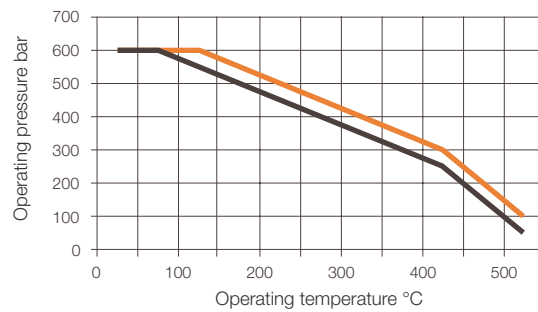
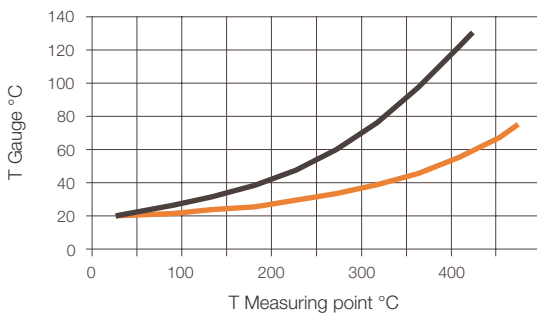

— MZB-711.7221 to MZB-711.7224 = multipart design
— MZB-711.7225 and MZB-711.7226 = one-part design

Order Details

Model	Connection meas. device	Process connection
MZB-711.7221	G 1/2 IG	G 1/4 AG
MZB-711.7222	G 1/2 IG	G 1/2 AG
MZB-711.7223	G 1/2 IG	1/4 NPT AG
MZB-711.7224	G 1/2 IG	1/2 NPT AG

Model	Connection meas. device	Process connection
MZB-711.7225	G 1/2 IG	G 1/2 AG
MZB-711.7226	1/2 NPT IG	1/2 NPT AG

Other connections upon request.